



The right door, whatever the property
Solutions for application in commerce and industry



The right solution, whatever the property – attractive doors by Novoferm

Novoferm offers planners and developers a wide-ranging programme of modern fire-resistant and multi-purpose doors. Our strengths include integrated property solutions, for which we offer innovative doors that are proven in practice. Individual or customised designs can, of course, be realised at any time.

As one of Europe's leading system providers of doors, garage doors, frames and drives, our products are manufactured to the latest state of technology. We not only meet very high standards of quality; we also combine extensive functionality with attractive design.





Contents

Fire-resistant doors	4
Technical specifications	6
T30-1 N2/50 flap, T30-1 N2/50, T30-1 H8-5	8
T30-2 N22/50, T30-2 N22	10
T90-1 N9, T90-1 N19	12
T90-2 N29, T90-2 N39	14
Size tables for T30/T90 standard doors	16
Smokeproof doors	18
Smokeproof steel doors	20
Steel doors	22
MZ-1, MZ-2, MZ 53-1, MZ 53-2	24
Special doors	26
Transformer doors, soundproof doors, detention doors	28
Technical specifications, drawings	30
Installation advantages, wall connections	30
Sills, anchor plans	33
Programme table	34

Tangible installation advantages of Novoferm doors

- 1. Rapid back-filling of the frames**
 - with approved moulded parts made of mineral wool
- 2. Invisible screw assembly**
 - simply screw together instead of welding
 - the top quality appearance of the frame is sustained
 - for fair-faced concrete and masonry
- 3. Dry mortarless construction / F90 mounting walls**
 - T90 doors for DIN walls starting at 100 mm, for virtually all standard firewall systems
 - T30 and multi-purpose doors with concealed screw assembly for flawless door appearance



Doors by Novoferm – more than just “steel doors”

Attractively designed with a thick rebate that even looks good in living areas, and elaborately finished - Novoferm steel doors are the ideal choice, even for sophisticated properties. And our standard doors are even available from stock in many basic dimensions. In addition to customised standard applications, Novoferm also offers doors that meet the special requirements of industry, energy supply or detention facilities.

Made-to-measure fire-resistant and multi-purpose doors

Regardless of whether you require fire resistance, smoke or sound protection, glazing or top panel, stainless steel or burglar resistance: The range offered by Novoferm encompasses seals for any required and/or stipulated application. Together with a wide choice of frame shapes, hardware and locking mechanisms.



T30 / T90 fire-resistant doors – inspiringly good

As a specialist for steel doors, Novoferm offers a wide range of fire-resistant doors that are all approved to general building code standards. Whether T30 or T90, standard version or version with top quality special finish - you will find the perfect solution for practically any application here. Our fire-resistant doors are all fully galvanised and primed. The galvanised and additionally powder-coated corner frames with sealing profile are also standard. Other frame or sill solutions are available to meet the respective statutory requirements. The attractive design of the door is rounded off by a wide choice of ergonomically designed hardware.





Standard means more than just “from the rack”

You can choose just the right fire-resistant doors to match your property from our wide range of available designs, sizes and finishes. We can also provide matching seals for various special applications – just tell us what you need and we will find the solution.



The right design to meet any standard

Our N series of fire-resistant doors is particularly suited for sophisticated properties. The elaborate finish, the design, which is even suitable for living areas, and the versatile range of special finishes make them the door of choice for demanding property developers.



The right glazing in case of fire

Novoferm offers fire-resistant doors with numerous types of standard-compliant glazing. Not only are special types of glazing available, the doors can also be supplied with optional individual window cut-outs. Please let us know your requirements.



Standard design

Special design

Door leaf: made of galvanised, mechanically specially aligned thin sheets, with rebate on three sides, therefore with thick rebate to match the front door (type H8-5 thin rebate), together with fire protection insulation.

Thermal insulation in accordance with DIN 52619. Glazed doors with fire-resistant glass in line with statutory requirements for interior use.

Frame: galvanised, standard version as corner frame with EPDM sealing profile. Screw fastening with masonry dowels on all single-leaf doors with a width ≥ 1250 mm and on all double-leaf doors.

Hardware: three-section hinge plates with ball bearings, pins, door closer in accordance with DIN EN 1154 (T30-1 doors with ball bearing hinge plate and spring plate in accordance with DIN 18272, some with upper door closer, dependent on size,

T90-1 doors always with upper door closer, optional spring plate up to 2m². Upper door closer for type H8-5 available at additional charge).

DPC mortise lock with draw-back latch, with black rounded handle set (turn-lock mounted).

Two-leaf doors with two upper door closers and additional automatic retracting bolt with handle for the inactive leaf and lock coordinator (T30-2 doors type N22/50 with rebate retracting bolt).

Surface: made of galvanised steel, primed (with environmentally friendly powder-coating in RAL 9016, traffic white).

Other frame designs instead of the standard frame (description, see pages 30/31. Only a 1.5 mm counterframe can be optionally used on T30-1 type H8-5).

Special sill design (description, see pages 32/33).

Fixed upper section on various types of T30.

Sealing profile between the frame and top panel and between the leaves.

Other hardware that complies with the statutory requirements for fire-resistant doors is optionally available, such as handles, slide channel door closers (with integrated lock coordinator on two-leaf doors), panic locks.

ITS96 door closer system integrated into the leaf (T30-1 type N2/50 and T30-2 type N22/50 only, full leaf or glazed in each case).

Electric door opener, monitor contacts or locks, hold-open systems, and much more.

T30 and T90 fire-resistant glazing with UV protection on one side for areas exposed to direct sunlight.

Door leaf and frame made of stainless steel V2A - 1.4301 or V4A - 1.4571.

T30 doors



T30-1 type N2/50
Page 8



T30-1 type N2/50
Page 8



T30-1 type H8-5
Page 8



T30-2 type N22
Page 10



T30-2 type N22/50
Page 10



T90 doors



T 90-1 type N9
Page 12



T90-1 type N19
Page 12



T90-2 type N29
Page 14



T90-2 type N39
Page 14



Glazing

Although Novoferm generally supplies its multi-purpose and fire-resistant doors with various types of standard-compliant glazing, a wide range of special glazing options are also available.

Standard-compliant glazing comes in a choice of different cut-out sizes and shapes - rectangular, round or diamond-shaped. Wire laminated or VSG laminated glass is available, as are several types of ISO glazing up to 19 mm thick.

Anyone considering one of the rectangular types of special glazing can choose from seven different types of glass. The shape and size of the window cut-out can be designed with great flexibility. Your best bet is to talk to us directly.

Technical description

Definition: The purpose of self-closing fire-resistant doors is to prevent fire from penetrating wall openings when installed.

Approval: Our fire-resistant seals have been officially tested in accordance with DIN 4102 and have been awarded general building code approval by means of certification issued by the Deutsches Institut für Bautechnik, Berlin.

Quality surveillance: Compliance with the seal requirements defined in the approval certification is monitored by a recognised quality protection association. Proof of the same is provided on an embossed plate on each fire-resistant seal, indicating the

mark with information on design, registration number, quality protection association, manufacturer and year of manufacture.

Installation: Both the wall in which the fire-protection seal is to be installed and the fastening of the frame must comply with the approval requirements.

T30-1 fire-resistant doors

Single-leaf, fire-retarding steel doors and wall flaps, with thick or thin rebate

Single, full-leaf steel doors, fire-retardant in accordance with DIN 4102, with door closer (depending on the model). Door leaf and frame galvanised and primed (powder-coated) in RAL 9016.

Hardware

(If standard hardware is used on types N2/50, the profile cylinder must be lengthened by 0/10 mm)

Frames

Standard: Corner frame with sealing profile, counterframe optional (additional charge for H8-5). Wrap-around or block frames or frames for butt wall connections are optionally available for types N2/50

Sills

N2/50 flap: B1 standard, B2 optional for N2/50 door: A standard, B1, B2, B3 and RS1 or RS2 optional

Surfaces

Door leaf and frame galvanised and primed (powder-coated) in RAL 9016.

The following can also be supplied on request

- **Fire-resistant glazing** (not for type H8-5)
- **Top panel** (not for type H8-5)
- **Smoke protection** in accordance with DIN 18095
- **Soundproofing** (not for models with top panel)
Types N2/50: 34 dB or 45 dB, tested to DIN EN ISO 140-3, evaluated in accordance with DIN EN ISO 717-1 (Laboratory value for full-leaf and RS1 sill)
Type H8-5: SV approx. 39 dB, tested to DIN 52210
- **Burglar resistance** (not for models with top panel and not for type H8-5)
tested on both sides to DIN ENV 1627 WK2
N2/50 door: only for floor recess up to > 20 mm. (Burglar resistance for N2/50 doors and flaps not permitted for F90 walls made of gypsum plasterboard or foam mortar)
- **In stainless steel** (not for type H8-5)



T30-1 type N2/50
Wall flap with thick rebate



T30-1 type N2/50
Door with thick rebate



T30-1 type H8-5
Door with thin rebate

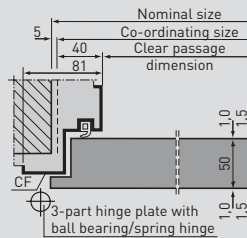

Horizontal section

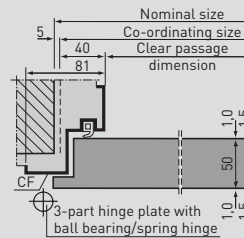

Horizontal section

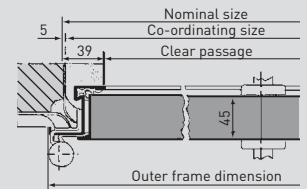

Horizontal section

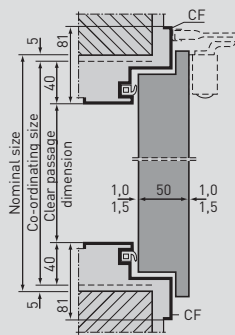

Vertical section

Door closer needed for model with smoke protection or models installed in walls made of foam mortar or gypsum plasterboard.

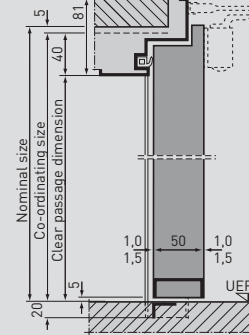

Vertical section

Door closer needed for 1.5 mm sheet thickness and CS > 1000 x 2125 mm or when installed in walls made of foam mortar or gypsum plasterboard or for smoke protection in accordance with DIN 18095.

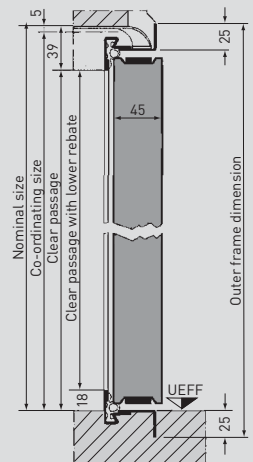

Vertical section



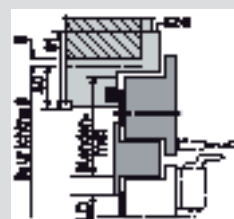





Door closer in accordance with DIN 18263 part 2 additionally possible.



Vertical section of top panel

T30-1 fire-resistant doors

Technical data

Resistance class/Type Designation		T30-1 N2/50 Wall flap	T30-1 N2/50 Door	T30-1 H8-5 Door (wall flap on request)
Models				
Approved dimensions	Co-ordinating size (CS)	Width min. – max.	500 - 1250	625 - 1350
		Height min. – max.	500 - 1500	1500 - 2500
	with top panel	Max. height	-	3500
	of which: Door	Max. height	-	2450
	Smoke protection with top panel	Max. CS	-	3000
Door leaf	Approx. leaf thickness		53	53
	Approx. sheet thickness	up to CS 500 x 1750	1.0 (optionally 1.5)	1.0 (optionally 1.5)
	Active leaf		-	-
	Inactive leaf		-	-
	Type of opening	in accordance with DIN	Left or right	Left or right
Walls	Masonry		≥ 115	≥ 115
	Concrete		≥ 100	≥ 100
	Foam mortar block/precision blocks		≥ 115	≥ 115
	Reinforced foam mortar wall panels		≥ 100	≥ 100
	F90 walls made of gypsum plasterboard (in accordance with DIN 4102 part 4, table 48)		≥ 100	≥ 100
Versions	Fire-retardant in accordance with DIN 4102		•	•
	With fire-resistant glazing		-	•
	With additional top panel		-	•
	With additional smoke protection		•	•
	With additional soundproofing		•	• (extra charge)
	With additional burglar resistance		•	-
	In stainless steel		•	-
F30 types of glazing	Standard rectangular types of glazing with glazing profiles made of steel or, optionally, aluminium or stainless steel CS 2500 x 2500 or more pedestal moulding height ≥ 625 needed	-		
	Standard round types of glazing with glazing profiles made of steel or, optionally, stainless steel	-		
	Special optional glazing, 150 x 150 to 913 x 1921, also available as multi-pane glazing, frieze widths ≥ 155 with glazing profiles made of steel or, optionally, aluminium or stainless steel	-		
Approval number		Z-6.12-1482	Z-6.12-1482	Z-6.12-1604

• possible – not possible

All dimensions indicated in mm, CS = Co-ordinating size, OFD = Outer frame dimension, CP = Clear passage dimension

T30-2 fire-resistant doors

Two-leaf, fire-retarding steel doors with thick rebate

Double, full-leaf steel doors, fire-retardant in accordance with DIN 4102, with door closer. Door leaf and frame galvanised and primed (powder-coated) in RAL 9016.

Hardware

Type N22/50: standard 3 hinges on each leaf on CS 2500 x 2500 or more (if standard hardware is used, the profile cylinder must be lengthened by 0/10 mm for type N22/50 and by 5/15 mm for type N22)

Frames

Standard: Corner frame with sealing profile, counterframe, wrap-around or block frame or frame for butt wall connection optionally available

Sills

Standard: A floor level, B1, B2, B3 with four-sided continuous frame or C with lower rebate or RS1 sealing sills with lowerable floor seal and/or RS2 hump sill optionally available

Surfaces

Door leaf and frame galvanised and primed (powder-coated) in RAL 9016.

The following can also be supplied on request

- **Fire-resistant glazing**
- **Top panel**
- **Smoke protection** in accordance with DIN 18095 (Type N22/50 tested for RS1 sill, type N22 for RS1 sill and centre rebate seal)
- **Soundproofing** (not for models with top panel)
Type N22/50: 35 dB, tested to DIN EN ISO 140-3, evaluated in accordance with DIN EN ISO 717-1 (laboratory value for full-leaf and RS1 sill)
Type N22: 38 dB, tested to DIN 52210 (laboratory value for full-leaf, RS1 sill and centre rebate seal)
- **Burglar resistance** (not for versions with top panel and not for type N22) tested to both sides to DIN ENV 1627 WK2 (full-leaf up to 2500 x 2500 mm, only versions with floor recess > 20 mm. Not permitted for F90 walls made of gypsum plasterboard or foam mortar)
- **In stainless steel** (not for type N22)



T30-2 type N22 / 50
Door with thick rebate



T30-2 type N22
Door with thick rebate

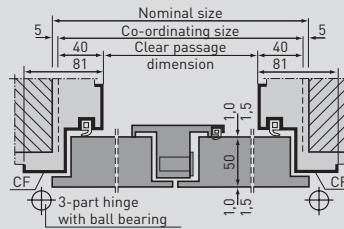

Horizontal section

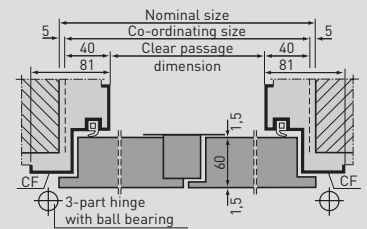

Horizontal section

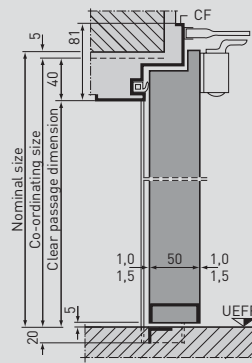

Vertical section

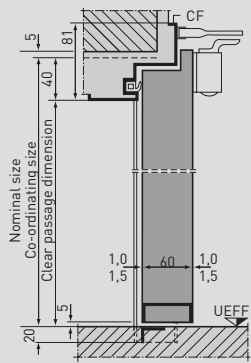

Vertical section

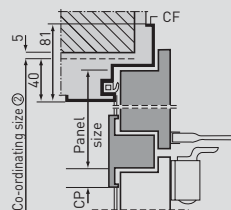



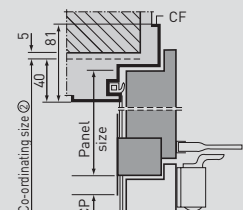

Vertical section of top panel

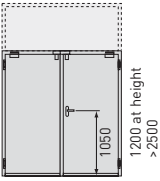
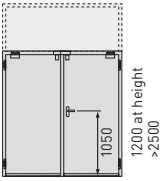
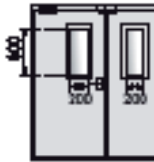
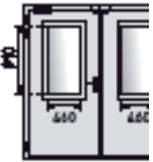

Vertical section of top panel

T30-2 fire-resistant doors

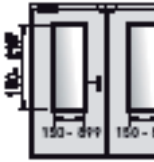
Technical data

Resistance class/Type Designation		T30-2 type N22/50 Door	T30-2 type N22 Door
Models			
Approved dimensions	Co-ordinating size (CS)	Width min. - max.	1375 - 3000
		Height min. - max.	1750 - 3000
	with top panel	Max. height	3500
	of which: Door	Max. height	2450
	Smoke protection with top panel	Max. CS	3500
Door leaf	Approx. leaf thickness		53
	Approx. sheet thickness	up to CS 2500 x 2500	1.0 (optionally 1.5)
		CS 2500 x 2500 mm or more	1.5
	Active leaf	Width min. - max.	709 - 1418
	Inactive leaf	Width min. - max.	545 - 1500
	Type of opening	in accordance with DIN	Left or right
Walls	Masonry	Door size < 2500 x 2500	≥ 115
		Door size > 2500 x 2500 with top panel	≥ 175
	Concrete	Door size < 2500 x 2500	≥ 100
		Door size > 2500 x 2500 with top panel	≥ 140
	Foam mortar block/precision blocks	Door size < 2500 x 2500	≥ 175
		Door size > 2500 x 2500	≥ 240
	Reinforced foam mortar wall panels		≥ 175
	F90 walls made of gypsum plasterboard (in accordance with DIN 4102 part 4, table 48)	Door size < 2500 x 2500	≥ 100
Door size > 2500 x 2500		≥ 125	
Versions	Fire-retardant in accordance with DIN 4102	•	•
	With fire-resistant glazing	•	•
	With additional top panel	•	•
	With additional smoke protection	•	•
	With additional soundproofing	•	•
	With additional burglar resistance	•	-
	In stainless steel	•	-
F30 types of glazing	Standard rectangular types of glazing with glazing profiles made of steel or, optionally, aluminium or stainless steel CS 2500 x 2500 or more pedestal moulding height ≥ 625 needed		
	Standard round types of glazing with glazing profiles made of steel or, optionally, stainless steel		
	Special optional glazing, 150 x 150 to 899 x 2167 200 x 300 to 1100 x 2186, also available as multi-pane glazing, frieze widths ≥ 155 with glazing profiles made of steel or, optionally, aluminium or stainless steel		
Approval number	Z-6.14-1511	Z-6.14-1204	

• possible – not possible

All dimensions indicated in mm, CS = Co-ordinating size, OFD = Outer frame dimension, CP = Clear passage dimension

T90-1 fire-resistant doors

Single leaf, fire-resistant steel doors and wall flaps with thick rebate

Single, full-leaf steel doors and/or flaps, fire-retardant in accordance with DIN 4102, with door closer. Door leaf and frame galvanised and primed (powder-coated) in RAL 9016.

Hardware

(if standard hardware is used, the profile cylinder must be lengthened by 5/15 mm)

Frames

Standard: Corner frame with sealing profile, counterframe, wrap-around or block frame or frame for butt wall connection optionally available

Sills

Type N9: Standard: B1, B2, B3 with four-sided continuous frame, A, C, RS1 or RS2 optionally available

Type N19: Standard: A floor level, B1, B2, B3 with four-sided continuous frame or C with lower rebate or RS1 sealing sills with lowerable floor seal and/or RS2 hump sill optionally available

Surfaces

Door leaf and frame galvanised and primed (powder-coated) in RAL 9016.

The following can also be supplied on request

- **Fire-resistant glazing**

(Type N9: min. frieze widths, 4-sided 237 mm)

- **Smoke protection** in accordance with DIN 18095

- **Soundproofing**

Type N9: to 800 x 800 mm 40 dB, 800 x 800 mm or more 43 dB (tested for full-leaf and sill, B1 and B2)

Type N19: 35 dB (tested for full-leaf and RS1 sill)

both types tested to DIN EN ISO 140-3 evaluated in accordance with DIN EN ISO 717-1 (laboratory values)

- **Burglar resistance**

both sides tested to DIN ENV 1627 WK2 on full-leaf version, to CS 1250 x 2500 mm with floor recess > 20 mm on type N19.

(Burglar resistance not permitted on both types for fire-resistant mounting walls or foam mortar walls or for glazing on type N9)

- **In stainless steel** (not for type N19)



T90-1 type N9
Wall flap with thick rebate



T90-1 type N19
Door with thick rebate

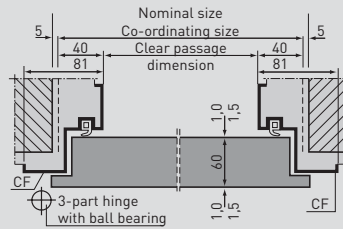

Horizontal section

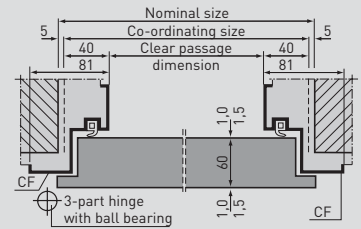

Horizontal section

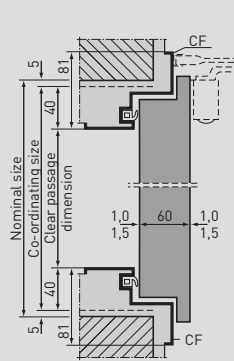

Vertical section



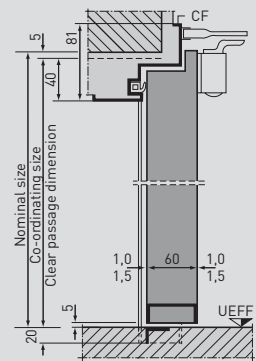

Door closer needed if CS surface > 1 m² or for smoke protection version or when installed in foam mortar or mounting walls.



Vertical section

T90-1 fire-resistant doors

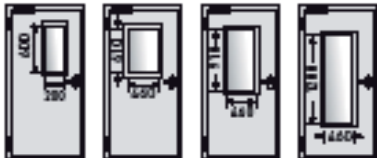
Technical data

Resistance class/Type Designation		T90-1 type N9 Wall flap	T90-1 type N19 Door
Models			
Approved dimensions	Co-ordinating size (CS)	Width min. – max. Height min. – max.	500 - 1250 500 - 1750
	with top panel	Max. height	-
	of which: Door	Max. height	-
	Smoke protection with top panel	Max. CS	-
Door leaf	Approx. leaf thickness		63
	Approx. sheet thickness	up to CS 500 x 1750	1.0 (optionally 1.5)
	Active leaf		-
	Inactive leaf		-
	Type of opening	in accordance with DIN	Left or right
Walls	Masonry		> 175
	Concrete		≥ 140
	Foam mortar block/precision blocks		≥ 175
	Reinforced foam mortar wall panels		≥ 150
	F90 walls made of gypsum plasterboard (in accordance with DIN 4102 part 4, table 48)		≥ 95
Versions	Fire-retardant in accordance with DIN 4102		•
	With fire-resistant glazing		•
	With additional top panel		-
	With additional smoke protection		•
	With additional soundproofing		•
	With additional burglar resistance		•
	In stainless steel		-
F90 types of glazing	Standard rectangular types of glazing with glazing profiles made of steel or, optionally, aluminium or stainless steel CS 2500 x 2500 or more pedestal moulding height ≥ 625 needed	-	
	Standard round types of glazing with glazing profiles made of steel or, optionally, stainless steel + A9	-	
	Special optional glazing, 130 x 150 to 770 x 1759, also available as multi-pane glazing, frieze widths > 237 with glazing profiles made of steel or, optionally, aluminium or stainless steel	-	
Approval number		Z-6.20-1919	Z-6.20-1919

• possible – not possible

All dimensions indicated in mm, CS = Co-ordinating size, OFD = Outer frame dimension, CP = Clear passage dimension

T90-2 fire-resistant doors

Two-leaf, fire-resistant steel doors with thick rebate

Double, full-leaf steel doors, fire-resistant in accordance with DIN 4102, with door closer. Door leaf and frame galvanised and primed (powder-coated) in RAL 9016.

Hardware

(if standard hardware is used, the profile cylinder must be lengthened by 10/10 mm for type N29 and 10/15 mm for type N39)

Frames

Standard: Corner frame with sealing profile, counterframe, wrap-around or block frame or frame for butt wall connection optionally available

Sills

Standard: A floor level, B1, B2, B3 with four-sided continuous frame or C with lower rebate or RS1 sealing sills with lowerable floor seal or RS2 hump sill for type N29 optionally available

Surfaces

Door leaf and frame galvanised and primed (powder-coated) in RAL 9016.

The following can also be supplied on request

- **Fire-resistant glazing** (not for type N39)
- **Smoke protection** in accordance with DIN 18095 (Type N39 tested with RS1 sill and centre rebate seal)
- **Soundproofing** 32 dB, tested to DIN EN ISO 140-3, evaluated in accordance with DIN EN ISO 717-1 (laboratory value for full-leaf, RS1 sill and centre rebate seal)
- **In stainless steel** (not for type N39)



T90-2 type N29
Door with thick rebate



T90-2 type N39
Door with thick rebate

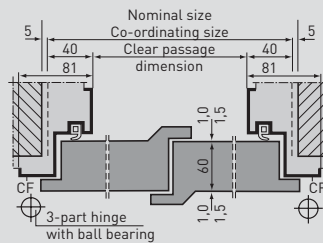

Horizontal section

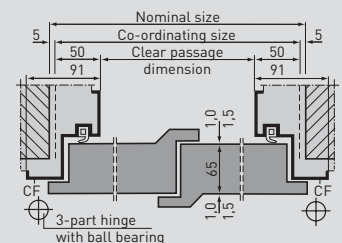

Horizontal section

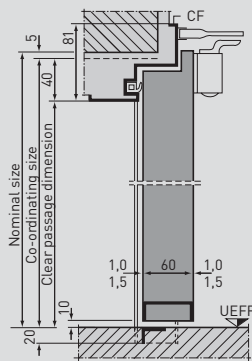



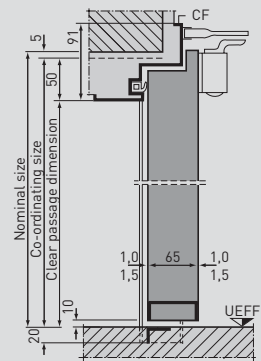



Vertical section

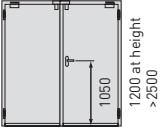
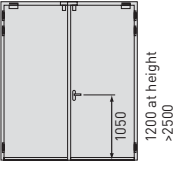
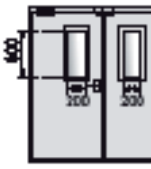
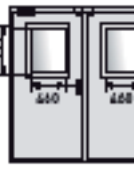
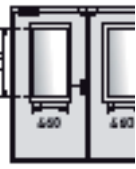

Vertical section

T90-2 fire-resistant doors

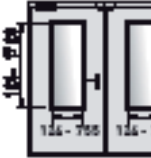
Technical data

Resistance class/Type Designation		T90-2 type N29 Door	T90-2 type N39 Door
Models			
Approved dimensions	Co-ordinating size (CS)	Width min. - max.	1375 - 2500
		Height min. - max.	1750 - 2500
	with top panel	Max. height	-
	of which: Door	Max. height	-
	Smoke protection with top panel	Max. CS	-
Door leaf	Approx. leaf thickness		63
	Approx. sheet thickness		1.0 (optionally 1.5)
	Active leaf	Width min. - max.	729 - 1229
	Inactive leaf	Width min. - max.	500 - 1229
	Type of opening	in accordance with DIN	Left or right
Walls	Masonry		≥ 175
	Concrete		≥ 140
	Foam mortar block/precision blocks		≥ 175
	Reinforced foam mortar wall panels		≥ 150
	F90 walls made of gypsum plasterboard (in accordance with DIN 4102 part 4, table 48)		≥ 95
			On request
Versions	Fire-retardant in accordance with DIN 4102		•
	With fire-resistant glazing		•
	With additional top panel		-
	With additional smoke protection		•
	With additional soundproofing		•
	With additional burglar resistance		-
	In stainless steel		•
F90 types of glazing	Standard rectangular types of glazing with glazing profiles made of steel or, optionally, aluminium or stainless steel CS 2500 x 2500 or more pedestal moulding height ≥ 625 needed		
			
	Standard round types of glazing with glazing profiles made of steel or, optionally, stainless steel + A9		
			Caution: Glazing only possible for type T90-2 N29!
Special optional glazing, 124 x 124 to 755 x 1728, also available as multi-pane glazing, frieze widths > 237 with glazing profiles made of steel or, optionally, aluminium or stainless steel			
Approval number		Z-6.20-1919	Z-6.13-1987

• possible – not possible

All dimensions indicated in mm, CS = Co-ordinating size, OFD = Outer frame dimension, CP = Clear passage dimension

Standard sizes

T30 fire-resistant doors, single-leaf

T30 fire-resistant doors, two-leaf

Co-ordinating size (Order size)	Nominal size (see below for calculation details)	Clear passage dimensions (see below for calculation details)	Outer frame dimensions (see below for calculation details)
T30-1 type N2/50 wall flap			
750 x 750	760 x 760	670 x 670	832 x 832
750 x 875	760 x 885	670 x 795	832 x 957
800 x 800	810 x 810	720 x 720	882 x 882
875 x 875	885 x 885	795 x 795	957 x 957
875 x 1000	885 x 1010	795 x 920	957 x 1082
875 x 1250	885 x 1260	795 x 1170	957 x 1332
1000 x 1000	1010 x 1010	920 x 920	1082 x 1082
1000 x 1250	1010 x 1260	920 x 1170	1082 x 1332
1250 x 1250	1260 x 1260	1170 x 1170	1332 x 1332

Co-ordinating size (Order size)	Nominal size (see below for calculation details)	Clear passage dimensions (see below for calculation details)	Outer frame dimensions (see below for calculation details)
T30-1 type N2/50 door			
750 x 2000	760 x 2005	670 x 1959	832 x 2060
750 x 2125	760 x 2130	670 x 2084	832 x 2185
875 x 1875	885 x 1880	795 x 1834	957 x 1935
875 x 2000	885 x 2005	795 x 1959	957 x 2060
875 x 2125	885 x 2130	795 x 2084	957 x 2185
1000 x 2000	1010 x 2005	920 x 1959	1082 x 2060
1000 x 2125	1010 x 2130	920 x 2084	1082 x 2185
1125 x 2000	1135 x 2005	1045 x 1959	1207 x 2060
1125 x 2125	1135 x 2130	1045 x 2084	1207 x 2185
1250 x 2000	1260 x 2005	1170 x 1959	1332 x 2060
1250 x 2125	1260 x 2130	1170 x 2084	1332 x 2185
1250 x 2250	1260 x 2255	1170 x 2209	1332 x 2310
1250 x 2500	1260 x 2505	1170 x 2459	1332 x 2560

Outer frame dimensions all incl. 20 mm floor recess

Co-ordinating size (Order size)	Nominal size (see below for calculation details)	Clear passage dimensions (see below for calculation details)	Outer frame dimensions (see below for calculation details)
T30-1 type H8-5 wall flap			
750 x 875	760 x 885	682 x 807	792 x 893
800 x 800	810 x 810	732 x 732	842 x 818
875 x 875	885 x 885	807 x 807	917 x 893
875 x 1000	885 x 1010	807 x 932	917 x 1018
875 x 1250	885 x 1260	807 x 1182	917 x 1268

Co-ordinating size (Order size)	Nominal size (see below for calculation details)	Clear passage dimensions (see below for calculation details)	Outer frame dimensions (see below for calculation details)
T30-1 type H8-5 door			
750 x 1750	760 x 1755	682 x 1716	792 x 1784
750 x 1875	760 x 1880	682 x 1841	792 x 1909
750 x 2000	760 x 2005	682 x 1966	792 x 2034
800 x 1800	810 x 1805	732 x 1766	842 x 1834
800 x 1875	810 x 1880	732 x 1841	842 x 1909
800 x 2000	810 x 2005	732 x 1966	842 x 2034
875 x 1750	885 x 1755	807 x 1716	917 x 1784
875 x 1800	885 x 1805	807 x 1766	917 x 1834
875 x 1875	885 x 1880	807 x 1841	917 x 1909
875 x 2000	885 x 2005	807 x 1966	917 x 2034
875 x 2125	885 x 2130	807 x 2091	917 x 2159
1000 x 1875	1010 x 1880	932 x 1841	1042 x 1909
1000 x 2000	1010 x 2005	932 x 1966	1042 x 2034
1000 x 2125	1010 x 2130	932 x 2091	1042 x 2159

Outer frame dimensions all incl. 25 mm floor recess

Co-ordinating size (Order size)	Nominal size (see below for calculation details)	Clear passage dimensions (see below for calculation details)	Outer frame dimensions (see below for calculation details)
T30-2 type N22/50 door			
1500 x 2000***)	1510 x 2005	1420 x 1959	1582 x 2060
1500 x 2125****)	1510 x 2130	1420 x 2084	1582 x 2185
1750 x 2000****)	1760 x 2005	1670 x 1959	1832 x 2060
1750 x 2125****)	1760 x 2130	1670 x 2084	1832 x 2185
2000 x 2000	2010 x 2005	1920 x 1959	2082 x 2060
2000 x 2125	2010 x 2130	1920 x 2084	2082 x 2185
2000 x 2500	2010 x 2505	1920 x 2459	2082 x 2560
2125 x 2125	2135 x 2130	2045 x 2084	2207 x 2185
2250 x 2250	2260 x 2255	2170 x 2209	2332 x 2310
2500 x 2500	2510 x 2505	2420 x 2459	2582 x 2560

Outer frame dimensions all incl. 20 mm floor recess

***) Leaf division (instead of 1/2 : 1/2) approx. 1/3 : 2/3, active leaf CS 918

****) Leaf division (instead of 1/2 : 1/2) approx. 1/3 : 2/3, active leaf CS 959

Calculation of clear passage and outer frame dimensions (not for T90-2 type N39)

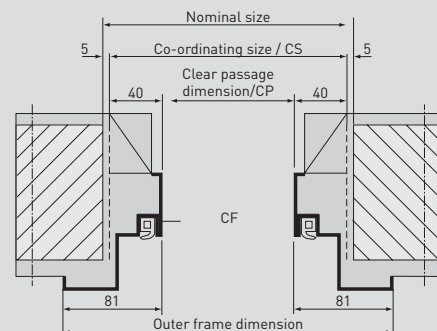

All dimensions indicated in mm, CS = Co-ordinating size, OFD = Outer frame dimension, CP = Clear passage dimension

Standard sizes

Fire-resistant doors T90, single-leaf

Fire-resistant doors T90, two-leaf

Co-ordinating size (Order size)	Nominal size (see below for calculation details)	Clear passage dimensions (see below for calculation details)	Outer frame dimensions (see below for calculation details)
T90-1 type N9 wall flap			
750 x 875	760 x 885	670 x 795	832 x 957
800 x 800	810 x 810	720 x 720	882 x 882
875 x 875	885 x 885	795 x 795	957 x 957
875 x 1000 ^{*)}	885 x 1010	795 x 920	957 x 1082
875 x 1250	885 x 1260	795 x 1170	957 x 1332
1000 x 1000 ^{*)}	1010 x 1010	920 x 920	1082 x 1082
1000 x 1250	1010 x 1260	920 x 1170	1082 x 1332

^{*)} Incl. door closer

Co-ordinating size (Order size)	Nominal size (see below for calculation details)	Clear passage dimensions (see below for calculation details)	Outer frame dimensions (see below for calculation details)
T90-1 type N19 door			
750 x 2000 ^{**)}	760 x 2005	670 x 1960	832 x 2061
750 x 2125 ^{**)}	760 x 2130	670 x 2085	832 x 2186
875 x 1875 ^{**)}	885 x 1880	795 x 1835	957 x 1936
875 x 2000 ^{**)}	885 x 2005	795 x 1960	957 x 2061
875 x 2125 ^{**)}	885 x 2130	795 x 2085	957 x 2186
1000 x 2000 ^{**)}	1010 x 2005	920 x 1960	1082 x 2061
1000 x 2125	1010 x 2130	920 x 2085	1082 x 2186
1125 x 2000	1135 x 2005	1045 x 1960	1207 x 2061
1125 x 2125	1135 x 2130	1045 x 2085	1207 x 2186
1250 x 2000	1260 x 2005	1170 x 1960	1332 x 2061
1250 x 2125	1260 x 2130	1170 x 2085	1332 x 2186
1250 x 2250	1260 x 2255	1170 x 2210	1332 x 2312
1250 x 2500	1260 x 2505	1170 x 2460	1332 x 2561

Outer frame dimensions all incl. 20 mm floor recess

^{**)} Also available with spring hinge in accordance with DIN 18272

Co-ordinating size (Order size)	Nominal size (see below for calculation details)	Clear passage dimensions (see below for calculation details)	Outer frame dimensions (see below for calculation details)
T90-2 type N29 door			
1500 x 2000 ^{***)}	1510 x 2005	1420 x 1960	1582 x 2061
1500 x 2125 ^{***)}	1510 x 2130	1420 x 2085	1582 x 2186
1750 x 2000 ^{****)}	1760 x 2005	1670 x 1960	1832 x 2061
1750 x 2125 ^{****)}	1760 x 2130	1670 x 2085	1832 x 2186
2000 x 2000	2010 x 2005	1920 x 1960	2082 x 2061
2000 x 2125	2010 x 2130	1920 x 2085	2082 x 2186
2000 x 2500	2010 x 2505	1920 x 2460	2082 x 2561
2125 x 2125	2135 x 2130	2045 x 2085	2207 x 2186
2250 x 2250	2260 x 2255	2170 x 2210	2332 x 2311
2500 x 2500	2510 x 2505	2420 x 2460	2582 x 2561

Outer frame dimensions all incl. 20 mm floor recess

^{***)} Leaf division (instead of 1/2 : 1/2) approx. 1/3 : 2/3, active leaf CS 956

^{****)} Leaf division (instead of 1/2 : 1/2) approx. 1/3 : 2/3, active leaf CS 978

Calculation of clear passage and outer frame dimensions (not for T90-2 type N39)

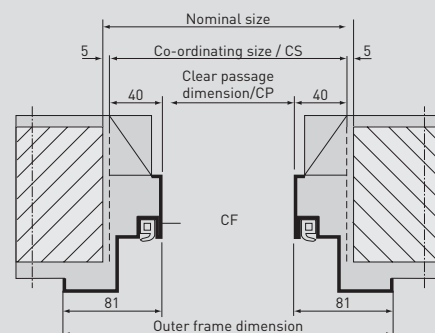

All dimensions indicated in mm, CS = Co-ordinating size, OFD = Outer frame dimension, CP = Clear passage dimension



Smokeproof doors – keeping the air safe to breathe

Fire insurance companies have known for a long time: Smoke damage is usually much more extensive than the damage caused purely by fire. So smokeproof seals are extremely important. Novoferm offers an entire range of smokeproof doors. These are substantially based on standard multi-purpose or fire-resistant T30 or T90 doors which are enhanced with special sealing systems and sills to guarantee optimal protection against smoke fumes.





Different sill design

Smokeproof doors approved in accordance with DIN 18095 must be fitted with a smokeproof seal to the floor. Depending on the application, Novoferm offers a choice of two approved sill designs: the "Athmer Stadi BS fire-resistant" (RS1) lowerable floor seal or a hump sill (RS2).

Door leaves can also be fitted with glazing

Even smokeproof doors can be supplied with glazing. F30 or F90 fire-resistant glazing is used, depending on whether the doors need to incorporate a fire protection function. Both types of glazing are available with single-sided UV protection for use in areas exposed to direct sunlight. Wire or ornamental wire glazing is, of course, also available, as is a wide range of ISO and laminated glass in various thicknesses.



Additional optional features



Smokeproof doors by Novoferm can also be supplied with top panel, soundproofing, burglar resistance or in stainless steel, depending on the type of door.



Smokeproof doors

Single-leaf, smokeproof steel doors, some with fire protection function.

Resistance class/Type Designation		RS-1 type MZ 53-1 Door	T30-1 type N 2/50 Wall flap	T30-1 type N2/50 Door	
Models					
Approved dimensions	Co-ordinating size (CS)	Width min. – max.	625 - 1350	500 - 1250	625 - 1350
		Height min. – max.	1750 - 2500	500 - 1500	1500 - 2500
	with top panel	Max. height	3000	-	3000
	of which: Door	Max. height	2450	-	2450
	Approx. leaf thickness		53	53	53
Approx. sheet thickness		1 or 1.5/2	1 or 1.5	1 or 1.5	
Versions	Standard design	thermally insulated	thermally insulated	thermally insulated	
	With glazing	•	-	•	
	With additional top panel	•	-	•	
	With additional fire retardancy	-	•	•	
	With additional soundproofing	35 dB	45 dB	34 dB	
	With additional burglar resistance	•	•	•	
	In stainless steel	•	•	•	
Test certificate/Registration number		P-120002238-11	Z-6.12-1482	Z-6.12-1482	



Resistance class/Type Designation		T30-1 type H8-5 Door	T90-1 type N9 Wall flap	T90-1 type N19 Door	
Models					
Approved dimensions	Co-ordinating size (CS)	Width min. – max.	625 - 1000	500 - 1250	625 - 1375
		Height min. – max.	1750 - 2125	500 - 1750	1750 - 2500
	with top panel	Max. height	-	-	-
	of which: Door	Max. height	-	-	-
	Approx. leaf thickness		45	63	63
Approx. sheet thickness		0.88	1 or 1.5	1 or 1.5	
Versions	Standard design	thermally insulated	thermally insulated	thermally insulated	
	With glazing	-	•	•	
	With additional top panel	-	-	-	
	With additional fire retardancy or fire resistance (T90)	•	•	•	
	With additional soundproofing	39 dB	43 dB	35 dB	
	With additional burglar resistance	-	•	•	
	In stainless steel	-	•	-	
Test certificate/Registration number		Z-6.12-1604	Z-6.20-1919	Z-6.20-1919	

• possible – not possible

All dimensions indicated in mm, CS = Co-ordinating size, OFD = Outer frame dimension, CP = Clear passage dimension

Smokeproof doors

Double-leaf, smokeproof steel doors, some with fire protection function

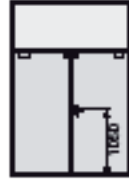
Resistance class/Type Designation		RS2 type MZ 53-2 Door	T30-2 type N22/50 Door	T30-2 type N22 Door
Models				
Approved dimensions	Co-ordinating size (CS)	Width min. – max.	1375 - 2500	1375 - 3000
		Height min. – max.	1750 - 2500	1750 - 3000
	with top panel	Height max.	3000	3500
	of which: Door	Height max.	2450	2450
	Approx. leaf thickness		53	53
Approx. sheet thickness		1 or 1.5/2	1 or 1.5	1 or 1.5
Versions	Standard design	thermally insulated	thermally insulated	thermally insulated
	With glazing	•	•	•
	With additional top panel	•	•	•
	With additional fire retardancy	–	•	•
	With additional soundproofing	34 dB	35 dB	38 dB
	With additional burglar resistance	•	•	–
	In stainless steel	•	•	–
Test certificate/Registration number		P-120002238-22	Z-6.14-1511	Z-6.14-1204

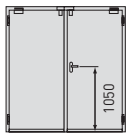
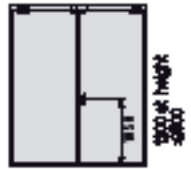
Resistance class/Type Designation		T90-2 type N29 Door	T90-2 type N39 Door
Models			
Approved dimensions	Co-ordinating size (CS)	Width min. – max.	1375 - 2500
		Height min. – max.	1750 - 2500
	Approx. leaf thickness		63
Approx. sheet thickness		1 or 1.5	1.5
Versions	Standard design	thermally insulated	thermally insulated
	With glazing	•	–
	With additional top panel	–	–
	With additional fire retardancy	•	•
	With additional soundproofing	32 dB	32 dB
	With additional burglar resistance	–	–
	In stainless steel	•	–
Test certificate/Registration number		Z-6.20-1919	Z-6.20-1987

• possible – not possible

All dimensions indicated in mm, CS = Co-ordinating size, OFD = Outer frame dimension, CP = Clear passage dimension



Multi-purpose steel doors – diversity for warehouse and office

Novoferm has designed its steel doors to meet a multitude of requirements. Sturdy and solid, they are perfectly able to cope with the harsh everyday life of a door, e.g. in the workshop or warehouse. Our multi-purpose doors are, however, also fitted with a rebate cover – similar to front doors – which makes them equally suitable for use in public areas, such as office or administrative environments. The diverse choice of glazing and a wide range of special models offer interesting options for adapting the doors to your individual needs. By the way: many of the standard sizes can be supplied at short notice.



Choice of features

Not just the shape and size of the glazing, but also the type of glass used in Novoferm multi-purpose doors can be matched to the widest range of different applications. Combinations with fanlight, smoke protection and soundproofing are equally possible.

Special requests? Talk to us

Our multi-purpose doors can be individually modified, depending on the structural requirements. One example of a more unusual solution is the use as an inspection opening with special activation.



Multi-purpose doors: Description

Door/door leaf: double-walled, made of galvanised sheet steel, filled with mineral wool for thermal insulation

Type MZ 53: rebate on three sides, the thick rebate, similar to front doors, is a special quality feature

Type MZ-1: rebate on two sides, thin rebate

Sill: Standard: floor level (A), sills with four-sided continuous frame (B1, B2, B3), with lower rebate (C) and sealing sills with lowerable floor seal (RS1) or hump sills (RS2) optionally available

Special features/Special doors

- Door closer
- Panic lock
- Butt wall connection
- Ventilation grating (incorporated into the leaf)
- Top panel/Fanlight
- Ventilation louvres/Special doors

Standard sizes

Single-leaf multi-purpose doors		Two-leaf multi-purpose doors	
CS 750 x 2000	CP 670 x 1959	CS 1500 x 2000*	CP 1420 x 1959
CS 875 x 1875	CP 795 x 1834	CS 1500 x 2125*	CP 1420 x 2084
CS 875 x 2000	CP 795 x 1959	CS 1750 x 2000*	CP 1670 x 1959
CS 875 x 2125	CP 795 x 2084	CS 1750 x 2125*	CP 1670 x 2084
CS 1000 x 2000	CP 920 x 1959	CS 2000 x 2000	CP 1920 x 1959
CS 1000 x 2125	CP 920 x 2084	CS 2000 x 2125	CP 1920 x 2084
CS 1125 x 2000	CP 1045 x 1959	CS 2000 x 2500	CP 1920 x 2459
CS 1125 x 2125	CP 1045 x 2084	CS 2125 x 2125	CP 2045 x 2084
CS 1250 x 2000	CP 1170 x 1959	CS 2250 x 2250	CP 2170 x 2209
CS 1250 x 2125	CP 1170 x 2084	CS 2500 x 2500	CP 2420 x 2459
CS 1250 x 2250	CP 1170 x 2209		

* up to CS width 1750 leaf division approx. 1/3 : 2/3, larger CSs symmetrical 1/2 : 1/2
All dimensions indicated in mm, CS = Co-ordinating size, OFD = Outer frame dimension, CP = Clear passage dimension

Full-leaf MZ 53 can be supplied immediately (longer lead time if **glazing** is required)
Sheet thickness 1 mm
Active leaf DIN left or DIN right

CS = Co-ordinating size (order size)
CP = Clear passage dimensions, whole door and/or both leaves

Multi-purpose doors

Single-leaf and two-leaf steel multi-purpose doors with thick or thin rebate

Single and double full-leaf doors made of steel, with double-walled thermal insulation, glazing optionally available. Door leaf and frame galvanised and primed (powder-coated) in RAL 9016.

Hardware

MZ-1 and MZ-2: Per leaf: 1 hinge plate and 1 spring hinge in accordance with DIN 18272. DPC mortise lock with drawback latch incl. tumbler lock insert with key, with black rounded handle set, turn lock mounted.

MZ 53-1 and MZ 53-2: Per leaf: 2x 3-part standard hinge plates (3 if CS height exceeds 2500 mm) with ball bearings; also available with 3D hinges on request.

Spring hinge per leaf up to CS 1250 x 2250 mm 1 securing pin (2 if height exceeds 2125 mm).

Reinforcement for door closer on hinge side. DPC mortise lock with drawback latch, with black rounded handle set (turn-lock mounted). MZ 53-2: Central transom profile on inactive leaf with concealed forend edge bolt (bolting upwards and downwards), incl. centre rebate seal

Profile cylinder

must be lengthened by 0/10 mm on MZ 53-1 and MZ 53-2 (if standard hardware is used)

Frames

MZ-1 and MZ-2: Corner frame with four-sided EPDM rubber seal, with masonry dowel

MZ 53-1 and MZ 53-2: Standard corner frame with four-sided EPDM rubber seal, with masonry dowel. Wrap-around frame, counter-frame, block frame or frame for lightweight partition walls optionally available

Surfaces

Door leaf and frame galvanised and primed (powder-coated) in RAL 9016.

The following can also be supplied on request

- Glazing
- Top panel/fanlight
- Soundproofing (not for type MZ-2)
- Smoke protection in accordance with DIN 18095

MZ 53-1: 625 x 1750 to 1350 x 2500 CS, with door closer and lowerable floor seal or hump sill

MZ 53-2: 1375 x 1750 to 2500 x 2500 CS, with door closer, lock coordinator, rebate retracting bolt, centre rebate seal, lowerable floor seal or hump sill



MZ-1 / MZ-2
Multi-purpose door with thin rebate



MZ 53-1 / MZ 53-2
Multi-purpose door with thick rebate

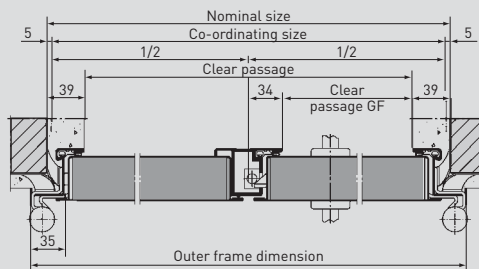
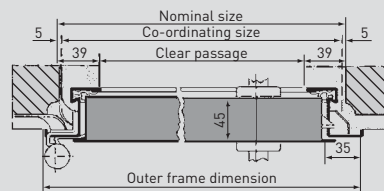

Horizontal section

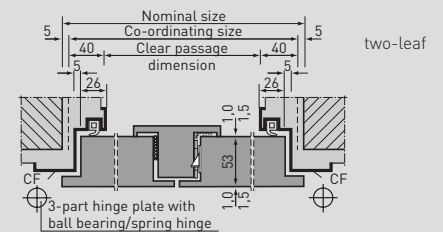
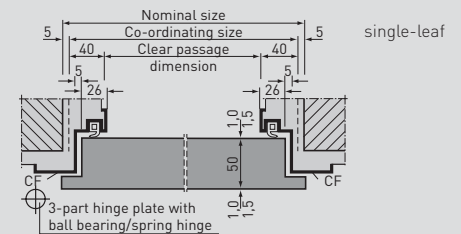

Horizontal section

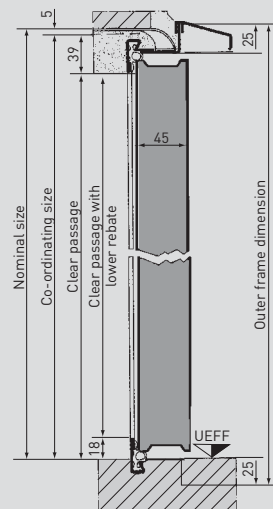

Vertical section

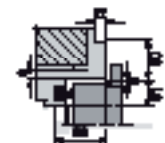

Header

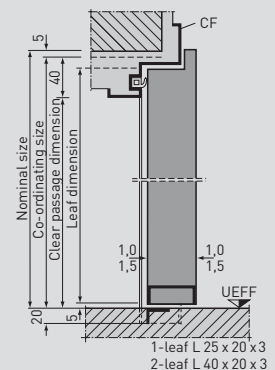

Door

sill A
1-leaf L 25 x 20 x 3
2-leaf L 40 x 20 x 3

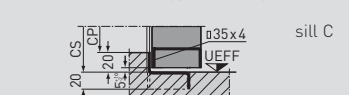











sill C

Vertical section

Multi-purpose doors

Technical data

Resistance class/Type Designation		MZ-1 / MZ-2 Single and two-leaf multi-purpose door		MZ 53-1 / MZ 53-2 Single and two-leaf multi-purpose door		
Models						
Leaf dimensions	Co-ordinating size (CS)	Width min. – max.	650 - 1250	1500 - 2250	500 - 1500	1000 - 3000
		Height min. – max.	1750 - 2125	2000 - 2125	1000 - 3500	1000 - 3500
	Approx. leaf thickness		45	45	53	53
		Sheet thickness	0.88	0.88	1 or 1.5 / 2	
	Type of opening	in accordance with DIN	Left or right		Left or right	
Versions	With thermal insulation (w/m ² K, w/o Glas) ¹⁾		1.7	–	0.8	0.8
	With additional glazing		•	•	•	•
	With additional top panel/fanlight		–	–	•	•
	With additional smoke protection		–	–	•	•
	With additional soundproofing ²⁾		approx. 39 dB	–	35 dB	34 dB
¹⁾ MZ-1 in acc. with EN ISO 12567-1, MZ 53-1 and MZ 53-2 in acc. with DIN 52619						
²⁾ MZ-1 = RWp on full-leaf, MZ 53-1 and MZ 53-2 soundproofing in acc. with DIN 52210, laboratory value for version with centre seal rebate and lowerable floor seal						
Available types of glazing	Standard rectangular types of glazing		Standard glass dimension for MZ-1 230 x 1360		Available standard glass dimensions: 200 x 600 500 x 400 460 x 910 460 x 1500	
	Standard diamond-shaped glazing		–		Available standard glass dimensions: 300 x 300 400 x 400 500 x 500	
	Standard round glazing		–		Available standard glass dimensions: Ø 300 Ø 400 Ø 514	
	Special glazing		–		From 150 x 150 to 1000 x 1500 mm Frieze width ≥155 Also available as multi-pane glazing with vertical and horizontal transoms	
Types of glass / Holding strips	Standard rectangular / diamond-shaped / round glazing				Glass holding strips	
	Wire glass 6 – 7 mm		–		•  angular	
	VSG laminated glass 6 mm		–		•  round	
	ISO wire glass/VSG (laminated glass) 19 mm		–		• Steel Steel + aluminium Steel / stainless steel	
	ISO-glass VSG (laminated glass)/VSG 19 mm		–			
	Special rectangular glazing					
	Wire glass 6 – 7 mm		–		• Glass holding strips	
	Wire ornamental glass 6 -7 mm		•		• for angular special glazing	
	ESG single pane security glass 6 mm		–		• 	
	VSG laminated glass 6 mm		–		• 	
ISO wire glass/VSG (laminated glass) 19 mm		–		• Steel / stainless steel with aluminium cover		
ISO wire ornamental glass/VSG (laminated glass) 19 mm		•				
ISO-glass VSG (laminated glass)/VSG 19 mm		–				

• possible – not possible All dimensions indicated in mm, CS = Co-ordinating size, OFD = Outer frame dimension, CP = Clear passage dimension

The secured window strip on glazed doors is standard fitted on the hinge side (opposite hinge side is also possible on request). All glazing dimensions listed above refer to the clear look-through per door leaf (sketch shows an example for door size 1000 x 2000 mm)

The standard steel glazing frames (powder-coated in RAL 9016) for rectangular glazing can additionally be fitted with cover profiles made from aluminium E6/EV1 anodised. Glazing profiles for round and rectangular glazing can also be supplied in polished stainless steel.



Special doors – for very special requirements

Novoferm offers a range of special doors to meet very specific requirements in property construction. Transformer doors guarantee sufficient air exchange in critical areas, whereas special doors for prisons or detention facilities are designed specifically to prevent any exchange. Soundproof doors also prevent exchange, since they ensure acoustic separation up to SV 48 dB.





Transformer doors guarantee optimal air flow

Our ventilation louvres are designed with a free geometrical cross-section of approx. 50% of the clear dimension to guarantee comprehensive air flow. On request, we can also integrate special supply air gratings into the door leaf, together with additional air extraction above the door if an even faster air flow is required.

A new definition of “one-way doors”

The use of detention doors is nowadays by no means restricted to prisons. We therefore manufacture steel doors with the typical features for even smallest-size series.

Time for peace and quiet

The environmental impact of noise is increasingly becoming a focus of awareness. Specially designed soundproof doors by Novoferm guarantee effective soundproofing up to SV 48 dB.



Special doors

Transformer doors, soundproof doors, detention/cell doors

Steel doors for special industrial, energy management or detention (prison) requirements. Door leaf and frame galvanised and primed (powder-coated) in RAL 9016.

Ventilation louvres for transformer doors

Special feature for multi-purpose doors, galvanised, free geometrical cross-section approx. 50% of the clear dimension:

- a) fixed installation in the door, with bolstered, galvanised insect screen
- b) fixed installation above the door, with L frame and transom (please indicate ceiling or header connection)
- c) free-standing installation: with Z frame, continuous on four sides for installation in masonry or concrete

Soundproof doors (special design) SV 48 dB soundproofing (laboratory value) and thermally insulated, tested to DIN EN ISO 140-3 by officially recognised testing agency, evaluated in accordance with DIN EN ISO 717-1

Detention doors/Cell doors (prisons)

Single-leaf steel cell doors that meet the special requirements of detention facilities

Door leaf

Rebate on three sides, double-walled, completely filled with gypsum plasterboard and mineral fibre panels (soundproof doors) and/or mineral wool mats (detention doors), overlap thickness of min. 20 mm on detention doors

Hardware

Soundproof doors: 2x three-part hinges with ball bearings, 1 E-65-24 DIN 18250 lock with catch and bolt, pre-assembled for on-site profile cylinder (profile cylinder must be lengthened by 5/15 mm if standard hardware is used), 1 handle set with short plate.

Detention doors: 2x three-part hinges with fixed pin and ball bearing baffle rings, 1x hinge lock, 1x 200° spy-hole with security rosette plates.

Leaf and frame are prepared for on-site cell mortise lock without espagnolette function (e.g. STUV 8.13.0101.3 or 4)

Frames

Corner frame with continuous rubber seal on three sides, complete with anchors, detention doors with floor parting angle

Sills

Soundproof doors with lowerable floor seal and B3 sill with continuous four-sided frame

Surfaces

Door leaf and frame galvanised and primed (powder-coated) in RAL 9016.



Transformer doors
Ventilation louvres



Soundproof doors
DB-1 type 48



Detention doors
Prison cell doors



... integrated into the leaf

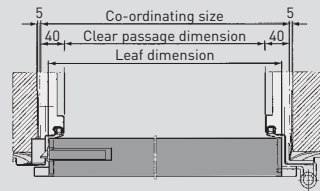

Horizontal section

Property-specific



... integrated into the leaf

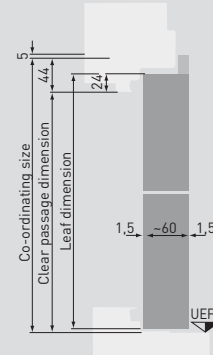
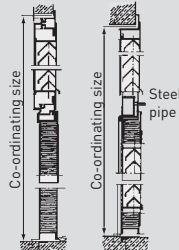

Vertical section

Property-specific

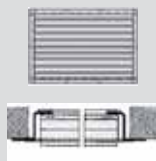

... free-standing installation

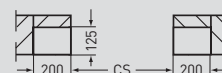
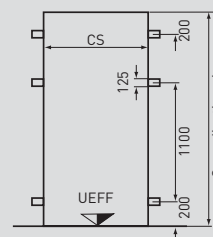

Anchor plan



Property-specific

Special doors

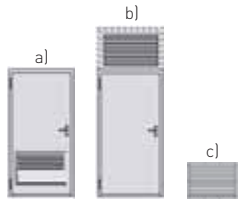
Technical data

Designation		Transformer doors Ventilation louvres	Soundproof doors DB-1 type 48	Detention doors Prison cell doors
Models				
Dimensions	Dimensions	a) 4-sided frieze ≥ 150 b) Height min. 250 max. 1250 c) min. 250 x 250 max. 2500 x 1500	CS min. 875 x 2000 max. 1250 x 2500 (750 x 2000 46 dB only)	CS min. 750 x 1875 max. 1250 x 2250
	Approx. weight	42 kg / m ²	-	-
	Approx. leaf thickness	-	63	54
	Approx. sheet thickness	-	1.5	2
Door leaf	Type of opening in accordance with DIN	Left or right	Left or right	Left or right
Version	With thermal insulation	-	•	•
	With soundproofing	-	•	•
	Optional special features	-	-	<ul style="list-style-type: none"> • Leaf and frame are prepared for on-site cell mortise lock with espagnolette function (e.g. STUV 8.13.0002.3 or 4) • Food flap, flush with the door leaf, standard size: 270 x 225 mm or available in special sizes, prepared for on-site food flap lock (e.g. STUV 8.13.0201.9) • Wrap-around frame • Steel security chain (padlock chain) • Additional locking bolt, 200 mm long (attached sliding bolt) • Integrated special sliding bolt with position-locking function • Special rubber seal for the frame • Special sill versions • Protective door plate in stainless steel • Noise reduction coating • Third door hinge • Door leaf with fire-resistant inlay • Can also be supplied complete with specified STUV locks, other types of lock optionally possible • Special features to meet your needs and/or prison requirements (on request)

• possible – not possible

All dimensions indicated in mm, CS = Co-ordinating size, OFD = Outer frame dimension, CP = Clear passage dimension

Installation advantages

of Novoferm steel doors

Invisible screw mounting in fair-faced concrete and fair-faced masonry

- Rapid installation of corner, block and add-on frames
- Easy installation: quickly and easily screwed
- Top quality appearance of the frame and door is sustained
- Choice of: Back-filling with mortar compound or approved mineral wool moulded sections from Novoferm
- up to CS 1250 x 2500 mm (1-leaf) or 2500 x 2500 mm (2-leaf)

suitable for following types of doors¹⁾:

T30 doors	T30-1 N2/50, T30-2 N22/50, T30-2 N22
T90 doors	T90-1 N9, T90-1 N19, T90-1 N29
MZ-doors	MZ 53-1, MZ 53-2

¹⁾ not available for doors with burglar resistance or top panel/fanlight

Corner frame Block frame Corner frame with add-on frame

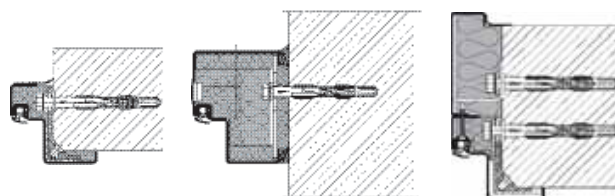

Novoferm screw-mounting frames are supplied together with the **approved installation kit**. The installation parts are already pre-assembled in the case of block frames.

Innovative installation solution, even for F90 mounting walls

- **T30 and MZ doors:** Frames can now be invisibly screw-mounted on all mounting walls specified in DIN 4102, part 4, table 48.
- New concealed installation technique for flawless door appearance
- Not a single visible screw on the frame facing
- Installation requires no more effort than conventional frames
- Ideal for installation in existing walls
- Suitable for standard wall thicknesses of 100, 125 and 150 mm
- Suitable for following types of doors: T30-1 N2/50, T30-2 N22/50, MZ 53-1, MZ 53-2
- **T90 doors** can now even be installed in 100 mm DIN walls
- And in virtually any standard F90 firewall system
- Any dimension between 500 x 500 mm (wall flap) and 2500 x 2500 mm (2-leaf door) is possible
- Suitable for following types of doors: T90-1 N9, T90-1 N19, T90-2 N29

T30 now with concealed screw mounting for a flawless door appearance



T90 for DIN walls starting at 100 mm, for virtually any mounting wall system

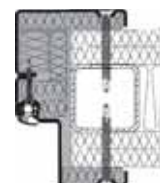

100 mm only

Quick back-filling of the frame with approved moulded mineral wool sections

- Marked reduction in thermal bridges compared with mortar filling
- Easy-to-mount cover strip creates a neat frame edge (on corner frame / corner frame with add-on frame for installation in masonry / concrete)
- Very simple handling generates cost benefits
- Can be combined with screw, plug and welded installation
- Approved for all T30 corner, block and add-on / overlapping counterframes, single or double leaf (except T30-2 type N22)
- up to CS 1350 x 2500 mm (1-leaf) or 2500 x 2500 mm (2-leaf)

suitable for following types of doors¹⁾:

T30 doors	T30-1 N2/50, T30-2 N22/50
MZ doors	MZ 53-1, MZ 53-2

¹⁾ not available for doors with burglar resistance or top panel/fanlight

Corner frame

for installation in masonry, concrete or foam mortar, with mineral wool back-filling



Corner frame with add-on frame

consisting of corner frame and add-on frame, for installation in masonry or concrete, with mineral wool back-filling



Corner and overlapping counterframe

for installation in masonry, concrete or foam mortar, with mineral wool back-filling

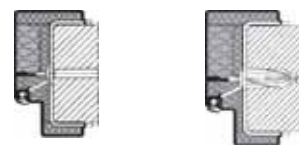

Block frame

for installation in masonry or concrete, with mineral wool back-filling



Our frame back-filling – nothing could be easier!

Perfectly made-to-measure and approved moulded mineral wool sections made by Novoferm are supplied for back-filling the types of frames shown on the right.

Frames

for T30 and T90 fire-resistant doors and steel multi-purpose doors

Approved frames

N series

CF Corner frame
with sealing profile



WF Wrap-around frame
with sealing profile



LBV Counterframe



30 mm facing



81 mm facing

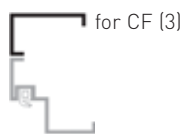

Facing, e.g. 70 mm
(Special facings available on request)

T30 Block frames for butt wall connection

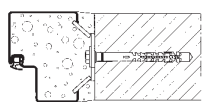

for weld-mounting

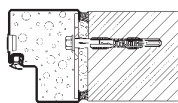
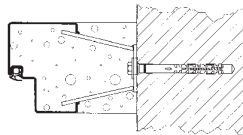

for screw-mounting

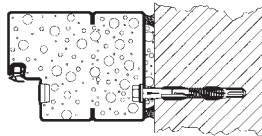

T90 Block frames for butt wall connection

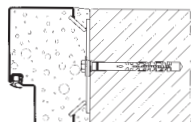

for weld-mounting

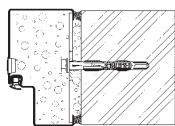
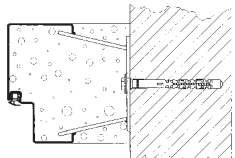

for screw-mounting

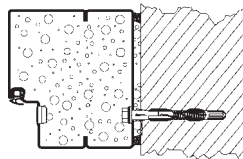

Frames for F90 walls

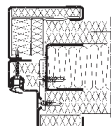

T30
with concealed
screw mounting

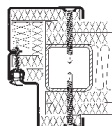

T90 for DIN walls
starting at 100 mm,
for virtually any
mounting wall system

N series

CF for screw mounting

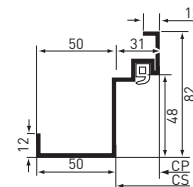
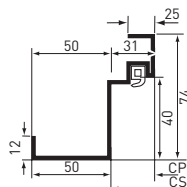

CF/WF

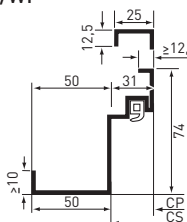

for approx. 53 mm leaf thickness

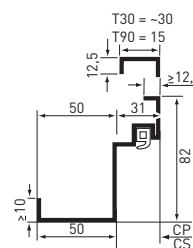

for approx. 63 mm leaf thickness

CF/WF (T90-2 type N39)

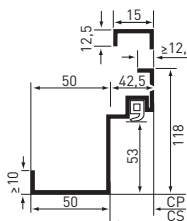

for approx. 68 mm leaf thickness

CF/WF (MZ-1/MZ-2)

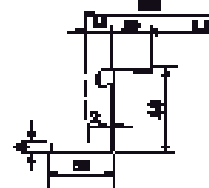

for 45 mm leaf thickness

T30 Block frames for screw mounting

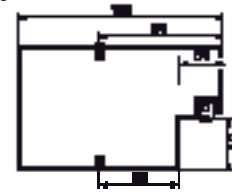
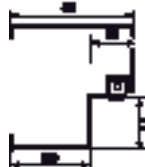

T90 Block frames for screw mounting

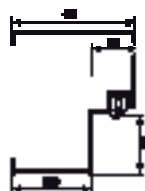

H series

H8-5 Corner frame

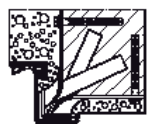

with combined
masonry dowels

H8-5 Corner/Counterframe

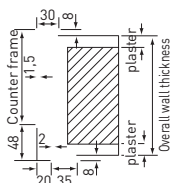

Calculation of clear passage and outer frame dimensions

(not for T90-2 type N39)

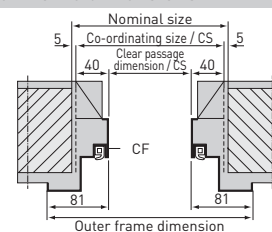

Frame mounting hardware

for T30 and T90 fire-resistant doors and steel multi-purpose doors

in masonry or concrete

in approved foam mortar walls

N series

(please also refer to the anchor plans overleaf)

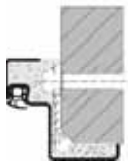

T30 Corner frame
Screw mounting in fair-faced concrete/fair-faced masonry



T90 Corner frame
Screw mounting in fair-faced concrete/fair-faced masonry



Corner frame
Dowel mounting in plaster-coated wall surfaces



Corner frame
Dowel mounting in fair-faced concrete/fair-faced masonry



Wrap-around frame
Dowel mounting

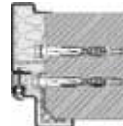

Corner frame with add-on frame
T30-1 type N2/50
T30-2 type N22/50
T30-2 type N22
Invisible screw mounting in fair-faced concrete/fair-faced masonry



Corner frame
Weld-on installation in fair-faced concrete/fair-faced masonry

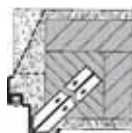

Corner frame
Wall anchor mounting on plaster-coated walls

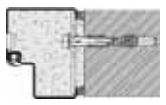

T30 BlockFrame
Screw mounting in fair-faced concrete/fair-faced masonry

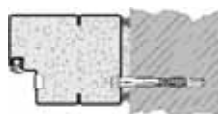

T30 BlockFrame with trimming profile
Screw mounting with butt wall connection in fair-faced concrete/fair-faced masonry



T90 BlockFrame
Screw mounting in fair-faced concrete/fair-faced masonry



T90 BlockFrame with trimming profile
Screw mounting with butt wall connection in fair-faced concrete/fair-faced masonry

H series



Corner frame T30 type H8-5
corner frame with combined masonry dowels

N series

for wall thickness ≥ 200 mm

(frames as approved, a door closer is always needed on T30-1 doors)



T30 Corner frame
Dowel mounting ①

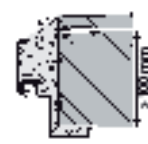

T90 Corner frame
Dowel mounting ①



T30/T90 Corner frame
Wall anchor mounting ②

for wall thickness < 200 mm



T30 Corner frame with counterframe, dowel mounting ①
(for wall thickness < 200 mm)

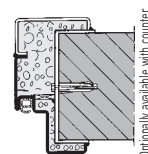

T90 Corner frame with counterframe, dowel mounting ①
(for wall thickness < 200 mm)





① Frame welded to pre-dowelled stirrup anchor. Building code-compliant foam mortar dowels needed.

② Frame fastened with frame anchors in cement mortar.

Please refer to the respective types of door for information on requisite minimum wall thicknesses

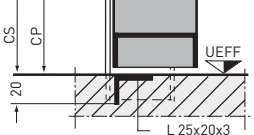
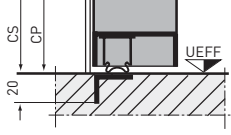
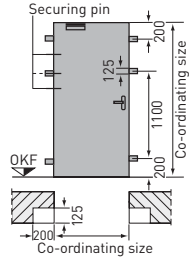
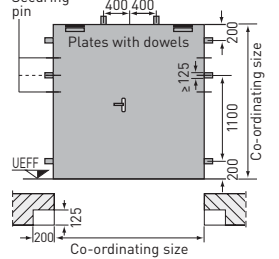
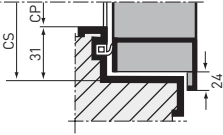
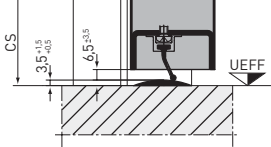
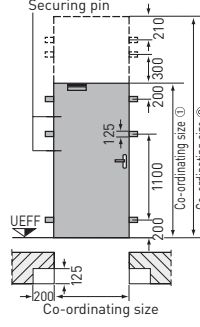
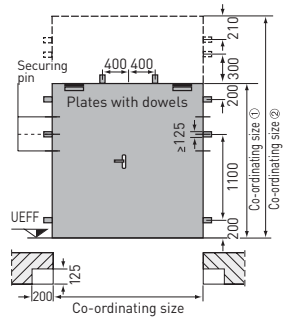
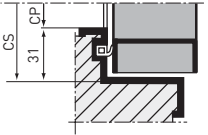
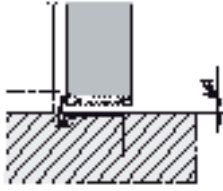
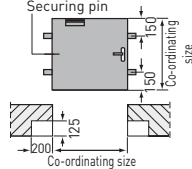
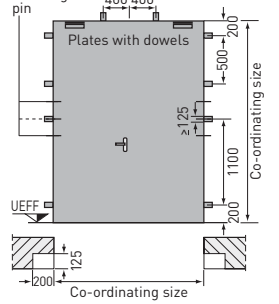
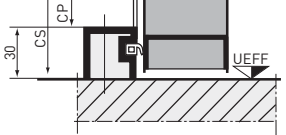
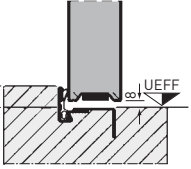
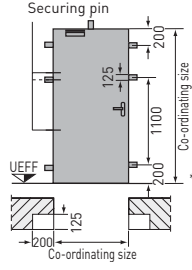
Sills, anchor plans

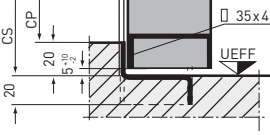

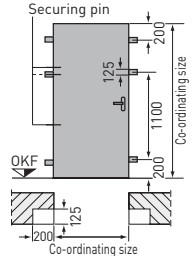
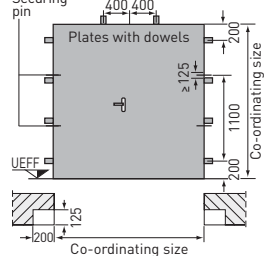







































for T30 and T90 fire-resistant doors and steel multi-purpose doors

Sills		Anchor plans	
<p>A sill floor level</p> 	<p>RS1 lowerable floor seal "Athmer Stadi BS fire-resistant"</p> 	<p>T30-1 type N2/50 T90-1 type N19</p> 	<p>T30-2 type N22/50 T30-2 type N22 < 2500 x 2500 mm T90-2 type N29</p> 
<p>B1 sill with continuous frame on 4 sides</p> 	<p>RS2 sealing sill II (hump sill)</p> 	<p>T30-1 type N2/50</p> 	<p>T30-2 type N22/50 T30-2 type N22 < 2500 x 2500 mm</p> 
<p>B2 sill with continuous frame on 4 sides</p> 	<p>T30 standard sill type H8-5 with continuous frame on 4 sides</p> 	<p>T30-1 type N2/50 wall flap T90-1 type N9 wall flap</p> 	<p>T30-2 type N22 > 2500 x 2500 mm T90-2 type N39</p> 
<p>B3 sill with continuous frame on 4 sides, door leaf rebate on 3 sides</p> 	<p>T30 sill type H8-5 with lower rebate</p> 	<p>T30 type H8-5</p>  <p>*Anchor plate for CS ≥ 875</p>	
<p>C sill with lower rebate</p> 	<p>T30 sill type H8-5 rebate sill with floor seal</p> 	<p>MZ-1</p> 	<p>MZ-2</p> 

If mounted without floor recess, an additional anchor must be fitted to both longitudinal posts at a height of 60 + 20 mm from the upper edge of the finished floor (UEFF).









Programme overview

Fire-resistant doors, smokeproof doors, multi-purpose doors and special doors

	Designation	Type	Version	Fire-resistance in accordance with DIN 4102-5	Smoke protection in accordance with DIN 18095	Sound insulation	Burglar-resistant RC class
Fire-resistant doors	H8-5	Door	1-leaf				No
	T 30-1 N2/50	Flap	1-leaf				
	T 30-1 N2/50	Door	1-leaf				
	T30-2 N22/50	Door	2-leaf				
	T30-2 N22	Door	2-leaf				No
	T90-1 N9	Flap	1-leaf				
	T90-1 N19	Door	1-leaf				
	T90-2 N29	Door	2-leaf				No
	T90-2 N39	Door	2-leaf				No
Smokeproof doors	MZ 53 RS-1	Door	1-leaf	No			No
	MZ 53 RS-2	Door	2-leaf	No			No
Multi-purpose doors	MZ-1	Door	1-leaf	No	No		No
	MZ-2	Door	2-leaf	No	No	No	No
	MZ 53-1	Door	1-leaf	No			No
	MZ 53-2	Door	2-leaf	No			No
Special doors	Transformer doors	Door	1 or 2 leaf	No	No	No	No
	Soundproof doors	Door	1 or 2 leaf	No	No		No
	Detention doors	Door	1-leaf	No	No		Special request

Programme overview

Fire-resistant doors, smokeproof doors, multi-purpose doors and special doors

Thermal insulation (documented)	Glazing	Top panel possible	Type of rebate	Co-ordinating size (in mm)	
				min.	max.
	No	No	Thin rebate	625 x 1750	1000 x 2125
	No	No	Thick rebate	500 x 500	1250 x 1500
	Yes	Yes	Thick rebate	625 x 1500	1350 x 2500
	Yes	Yes	Thick rebate	1375 x 1750	3000 x 3000
	Yes	Yes	Thick rebate	1375 x 1750	3000 x 3000
	Yes	No	Thick rebate	500 x 500	1250 x 1750
	Yes	No	Thick rebate	625 x 1750	1375 x 2500
	Yes	No	Thick rebate	1375 x 1750	2500 x 2500
	No	No	Thick rebate	1375 x 1750	3000 x 3000
	Yes	Yes	Thick rebate	625 x 1350	1350 x 2500
	Yes	Yes	Thick rebate	1375 x 1750	2500 x 2500
	Yes	No	Thin rebate	650 x 1750	1250 x 2125
No	Yes	No	Thin rebate	1500 x 2000	2250 x 2125
	Yes	Yes	Thick rebate	500 x 1000	1500 x 3500
	Yes	Yes	Thick rebate	1000 x 2000	3000 x 3500
No	No	Yes	Thick rebate	Property-specific	Property-specific
	No	No	Thick rebate	875 x 2000	1250 x 2500
	No	No	Thick rebate	750 x 1875	1250 x 2250

Novoferm. On-site. Direct. Europe-wide.

The Novoferm Group is one of the leading European system suppliers of doors, garage doors, frames and operators. We offer a large range of products and services for private, commercial and industrial applications. All our products are manufactured according to state-of-the-art technology and highest quality standards. We therefore integrate maximum functionality and innovative design. We manufacture our products in various international locations and with our Europe-wide sales network we are always able to deal with you - wherever you are!

Your Novoferm sales partner

Novoferm GmbH
Isselburger Straße 31
D-46459 Rees (Haldern)
Tel.: (02850) 910-0
Fax: (02850) 910-646
E-Mail: sales@novoferm.com
www.novoferm.com

